

Precision Rolled Ball Screws

PR Series/LPR Series

Compact ball nut heralding in the next generation standard.
Extended maintenance free operation with NSK K1®
lubrication unit and new grease retaining seal.
Suitable for high speed and long stroke operation.



A 25% reduction in the ball nut diameter compared to the current series

No backlash, high speed and long stroke operation is possible. Extended maintenance free operation achieved with **NSK K1**[®] lubrication unit and new grease retaining seal, thus contributing to total cost reduction.

Compact ball nut

- Saves assembly space
- Suitable for rotating ball nut applications because of its low inertia and balanced design

Remarkable improvement in sealing performance (introduction of grease retaining seal)

- Grease retention capabilities substantially enhanced
- Assists clean environment maintenance due to minimum grease scattering
- Superb sealing capabilities in contaminated environments

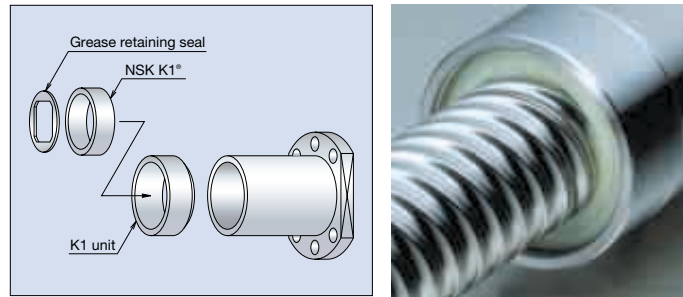

Maintenance free (equipped with NSK K1[®] lubrication unit as a standard feature)

NSK K1[®] lubrication unit, that is molded from resin and is impregnated with lubrication oil, supplies fresh oil onto the ball rolling surfaces. In unison with grease it retains the lubricating ability for an extended period of time. Since its first appearance on the market in 1996, it has been widely accepted in many industrial fields.

Accuracy grade

Accuracy grades of Ct5 and Ct7 are available.

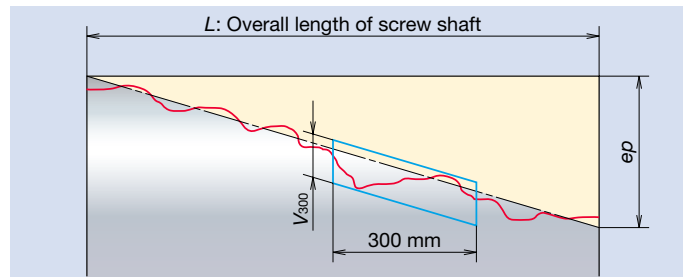

Grade	Ct5	Ct7
ep: Tolerance on specified travel	$ep = \frac{2 \cdot L}{300} \cdot V_{300}$ (mm)	
	L: Overall length of screw shaft	
Travel variation in a 300 mm range (anywhere in useful travel)	0.023 mm	0.052 mm

Options

Support unit (sold separately)

NSK provides the support bearing units to accompany the ball screw shafts.

For further details, please refer to the NSK catalog: Precision Machine Components (CAT. No. E3161).

The bearing journal configurations of the screw shaft are provided on the following pages.

Applications
Woodworking machines, general transporting equipment, feeders, robots, etc.

Precision Rolled Ball Screws PR Series/LPR Series



Ball nut dimensions

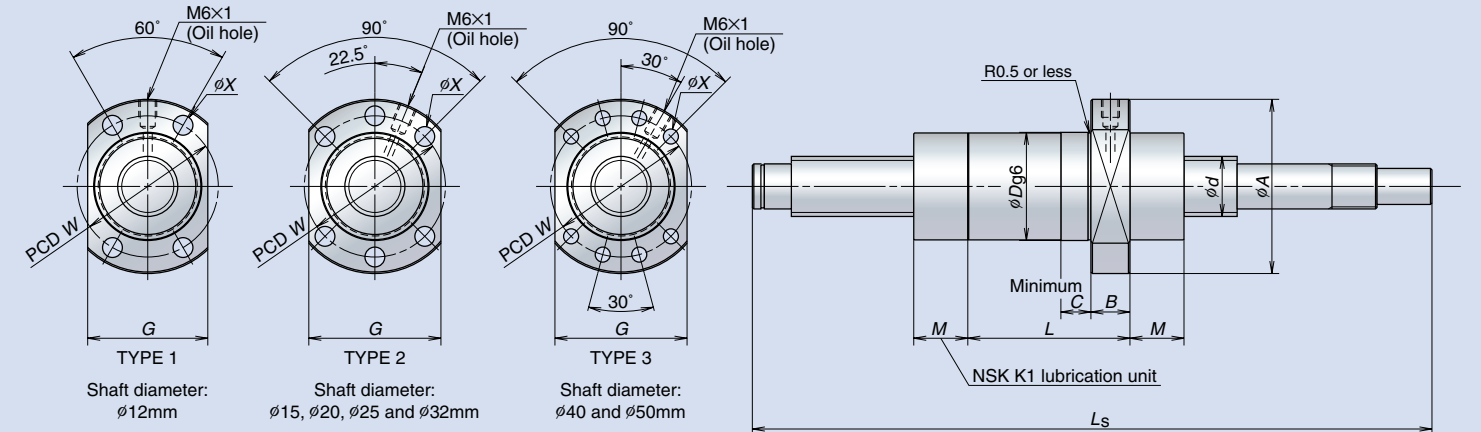

PR Series

Model No.	Shaft diameter d	Lead l	Effective turns of balls	Basic load rating (N)		Dimensions										Maximum screw shaft length			
				Dynamic load rating C_a	Static load rating C_{0a}	D	A	G	B	L	C	Type	W	X	M	Ct5		Ct7	
																Standard	On Request	Standard	On Request
PR1205	12	5	2.7×1	3 200	5 860	24	40	26	11	30	10	1	32	4.5	(18)	200 - 500	-1 000	200 - 900	-1 500
PR1505	15	5	2.7×1	5 460	10 200	28	48	40	11	30	10	2	38	5.5	(18)	200 - 600	-1 000	200 - 1 200	-1 500
PR1510	15	10	2.7×1	5 460	10 200	28	48	40	11	43	15	2	38	5.5	(18)	200 - 600	-1 000	200 - 1 200	-1 500
PR2005	20	5	2.7×1	8 790	18 500	36	58	44	13	31	10	2	47	6.6	(18)	300 - 800	-2 000	300 - 1 600	-2 000
PR2010	20	10	2.7×1	8 790	18 500	36	58	44	13	45	15	2	47	6.6	(18)	300 - 800	-2 000	300 - 1 600	-2 000
PR2505	25	5	4.7×1	15 700	40 900	40	62	48	12	42	10	2	51	6.6	(21)	300 - 2 500	-	300 - 3 200	-
PR2510	25	10	3.7×1	12 800	32 300	40	62	48	12	56	15	2	51	6.6	(21)	300 - 2 500	-	300 - 3 200	-
PR3210	32	10	3.7×1	19 000	51 500	50	80	62	12	59	10	2	65	9	(23)	300 - 2 500	-3 200	300 - 3 200	-4 000
PR3220	32	20	3.7×1	19 000	51 500	50	80	62	12	98	15	2	65	9	(23)	300 - 2 500	-3 200	300 - 3 200	-4 000
PR4010	40	10	3.7×1	33 800	89 900	63	93	70	14	60	10	3	78	9	(26)	500 - 1 600	-	500 - 3 200	-

LPR Series

Model No.	Shaft diameter d	Lead l	Effective turns of balls	Basic load rating (N)		Dimensions										Maximum screw shaft length			
				Dynamic load rating C_a	Static load rating C_{0a}	D	A	G	B	L	C	Type	W	X	M	Ct5		Ct7	
																Standard	On Request	Standard	On Request
LPR2020	20	20	1.7×2	9 890	21 600	36	58	44	13	54	25	2	47	6.6	(18)	300 - 800	-2 000	300 - 1 600	-2 000
LPR2525	25	25	1.7×2	11 000	27 500	40	62	48	12	63	30	2	51	6.6	(21)	300 - 2 500	-	300 - 3 200	-
LPR3232	32	32	1.7×2	16 300	43 900	50	80	62	14	79	40	2	65	9	(23)	300 - 2 500	-3 200	300 - 3 200	-4 000
LPR4040	40	40	1.7×2	29 000	76 200	63	93	70	16	94	45	3	78	9	(26)	500 - 4 000	-	500 - 4 500	-6 500
LPR5050	50	50	1.7×2	32 200	96 200	75	110	85	18	115	45	3	93	11	(26)	500 - 4 000	-	500 - 4 500	-6 500

1. Precision Rolled Ball Screws PR Series/LPR Series

1.1 Specification number

For ordering, please quote the specification number.

Reference number: **H S P 40 40 K 1 D 2002 S A1**

Accuracy grade and axial play
HSP (Ct5, axial play 0 mm)
VSP (Ct7, axial play 0 mm)

Screw shaft diameter (mm)

Lead (mm)

K: Equipped with NSK K1 unit
N: No NSK K1 unit
(Equipped with grease retaining seal only)

Number of nut

Bearing journal for fixed support side: please refer to the configuration of the screw shaft end outlined in the catalog.

Bearing journal for simple support side: please refer to the configuration of the screw shaft end outlined in the catalog.

Overall length of screw shaft
If the length is less than 1000 mm, enter 0 to the fourth digit.

Position of ball nut flange
D: Screw shaft drive side S: Opposite to drive side

1.2 Permissible rotational speed of precision rolled ball screws

We strongly recommend reviewing the allowable speed of the screw shaft.

The allowable rotational speed of the ball screw shall be checked on the following.

- d·N value, which is involved in damaging the ball re-circulation components
(Where, d: shaft diameter measured in mm, N: rotational speed measured in min⁻¹)
- Critical speed of the screw shaft (caused by the resonance of the screw shaft)

● Permissible d·N

Preferably $d \cdot N \leq 150\,000$. Please consult with NSK if your ball screw exceeds the limitation.

● Critical speed

See the chart below. For detailed calculations, please refer to the catalog: Precision Machine Component (CAT No. E3161).

Please consult NSK if the maximum rotational speed exceeds 5 000 min⁻¹, even both the critical speed of the screw shaft rotation and the d·N value are in ranges of the allowable limit.

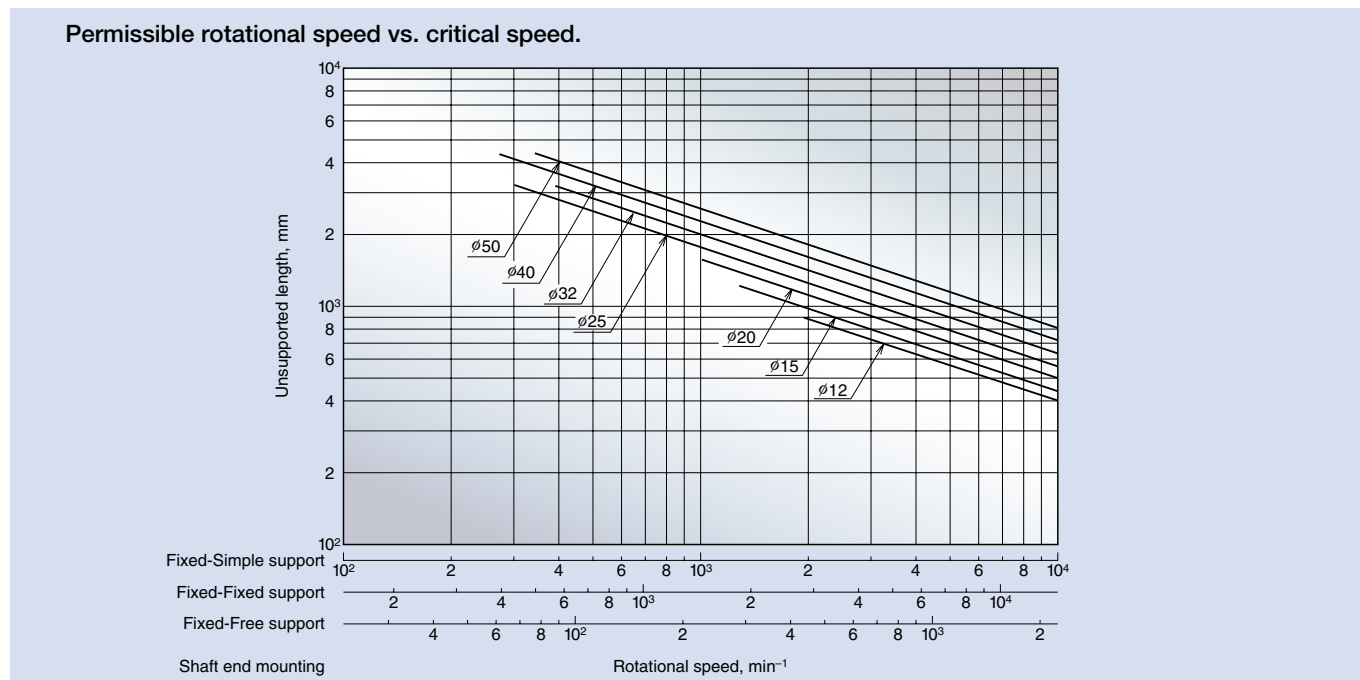

2. Recommendation of Screw Shaft End Configuration

2.1 Drive side shaft end and opposite end: P

Unit: mm

Screw shaft Diameter d
12
15
20
25
32
40
50

2.2 Drive side shaft end and opposite end: R

Unit: mm

Screw shaft Diameter d	Tap hole	
	Size M	Depth H
12	M3×0.5	9
15	M4×0.7	10
20	M6×1	12
25	M6×1	12
32	M6×1	12
40	M8×1.25	16
50	M8×1.25	16

2.3 Opposite to drive side shaft end: S

Unit: mm

Support unit Reference number	Screw shaft Diameter d	Bearing journal Diameter d ₃ g6	Bearing journal Length L ₃	Snap ring groove		
				Width n Tolerance	Diameter dn Tolerance	Position nL
WBK08S-01	12	6	9	0.8 ^{+0.1} ₀	5.7 ⁰ _{-0.06}	6.8
WBK12S-01	15	10	12	1.15 ^{+0.14} ₀	9.6 ⁰ _{-0.09}	9.15
WBK15S-01	20	15	13	1.15 ^{+0.14} ₀	14.3 ⁰ _{-0.11}	10.15
WBK20S-01	25	20	19	1.35 ^{+0.14} ₀	19 ⁰ _{-0.21}	15.35
WBK25S-01	32	25	20	1.35 ^{+0.14} ₀	23.9 ⁰ _{-0.21}	16.35
(6206)	40	30	22	1.75 ^{+0.14} ₀	28.6 ⁰ _{-0.21}	17.75
(6207)	50	35	25	1.75 ^{+0.14} ₀	33 ⁰ _{-0.21}	18.75

(): Reference number of bearing

2.4 Opposite to drive side shaft end: T

Unit: mm

Support unit Reference number	Screw shaft Diameter d	Bearing journal Diameter d ₃ g6	Bearing journal Length L ₃	Snap ring groove			Tap hole	
				Width n Tolerance	Diameter dn Tolerance	Position nL	Size M	Depth H
WBK08S-01	12	6	9	0.8 ^{+0.1} ₀	5.7 ⁰ _{-0.06}	6.8	-	-
WBK12S-01	15	10	12	1.15 ^{+0.14} ₀	9.6 ⁰ _{-0.09}	9.15	M3×0.5	9
WBK15S-01	20	15	13	1.15 ^{+0.14} ₀	14.3 ⁰ _{-0.11}	10.15	M3×0.8	10
WBK20S-01	25	20	19	1.35 ^{+0.14} ₀	19 ⁰ _{-0.21}	15.35	M6×1.0	12
WBK25S-01	32	25	20	1.35 ^{+0.14} ₀	23.9 ⁰ _{-0.21}	16.35	M6×1.0	12
(6206)	40	30	22	1.75 ^{+0.14} ₀	28.6 ⁰ _{-0.21}	17.75	M8×1.25	16
(6207)	50	35	25	1.75 ^{+0.14} ₀	33 ⁰ _{-0.21}	18.75	M8×1.25	16

(): Reference number of bearing

2.5 Drive side shaft end: C Opposite to drive side shaft end: U

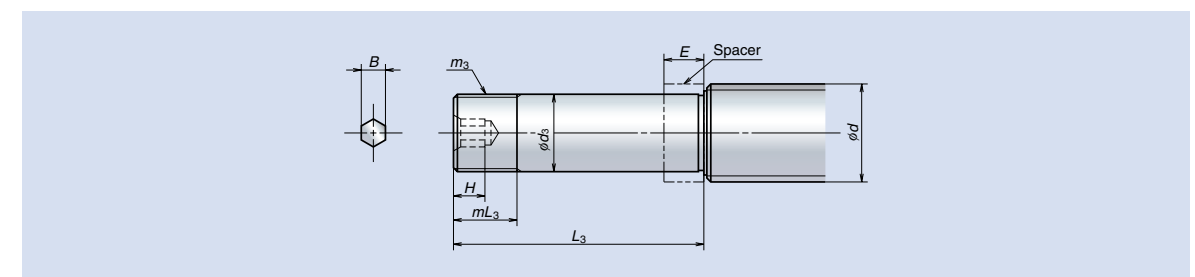

Unit: mm

Support unit		Spacer Reference number	Screw shaft Diameter d	Bearing journal Diameter d ₃ g6	Bearing journal Length L ₃	Lock nut thread Nominal M ₃	Lock nut thread Length mL ₃	Hexagon hole	
Reference number								Width across the flats B ^{+0.2}	Depth H
WBK08-01A	WBK08-11	WBK08K	12	8	32	M8×1	9	-	-
WBK12-01A	WBK12-11	WBK12K	15	12	35	M12×1	10	4	6
WBK15-01A	WBK15-11	WBK15K	20	15	50	M15×1	15	5	7
WBK20-01	WBK20-11	WBK20K	25	20	64	M20×1	16	6	8
WBK25-01	WBK25-11	WBK25K	32	25	76	M25×1.5	20	8	10
WBK30DF-31	-	-	40	30	89	M30×1.5	26	10	12
WBK35DF-31	-	-	50	35	92	M35×1.5	30	12	14

2.6 Opposite to drive side shaft end: V

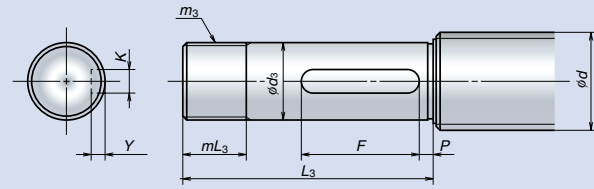

Unit: mm

Support unit		Screw shaft	Bearing journal		Lock nut thread		Key seat			
Reference number		Diameter d	Diameter d_3 g6	Length L_3	Nominal m_3	Length mL_3	Width K N9	Position P	Depth $Y_{-0.1}^{+0.1}$	Length F
WBK08-01A	WBK08-11	12	8	32	M8×1	9	2	3	1.2	14
WBK12-01A	WBK12-11	15	12	35	M12×1	10	4	3	2.5	20
WBK15-01A	WBK15-11	20	15	50	M15×1	15	5	3	3	25
WBK20-01	WBK20-11	25	20	64	M20×1	16	6	4	3.5	30
WBK25-01	WBK25-11	32	25	76	M25×1.5	20	8	4	4	40
WBK30DF-31		40	30	89	M30×1.5	26	8	5	4	40
WBK35DF-31		50	35	92	M35×1.5	30	10	5	5	50

2.7 Drive side shaft end: A1

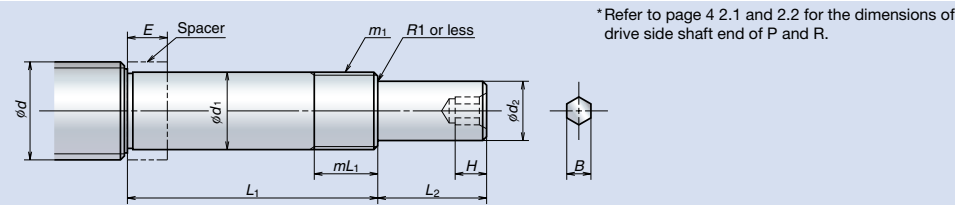

Unit: mm

Support unit		Spacer	Screw shaft	Bearing journal		Lock nut thread		Drive section		Hexagon hole	
Reference number		Reference number	Diameter d	Diameter d_1 g6	Length L_1	Nominal m_1	Length mL_1	Diameter d_2 h7	Length L_2	Width across the flats $B_{-0.2}^{+0.2}$	Depth H
WBK08-01A	WBK08-11	WBK08K	12	8	32	M8×1	9	6	10	-	-
WBK12-01A	WBK12-11	WBK12K	15	12	35	M12×1	10	10	15	4	6
WBK15-01A	WBK15-11	WBK15K	20	15	50	M15×1	15	12	20	5	7
WBK20-01	WBK20-11	WBK20K	25	20	64	M20×1	16	15	27	6	8
WBK25-01	WBK25-11	WBK25K	32	25	76	M25×1.5	20	20	33	8	10
WBK30DF-31		-	40	30	89	M30×1.5	26	25	61	10	12
WBK35DF-31		-	50	35	92	M35×1.5	30	30	63	12	14

2.8 Drive side shaft end: A3

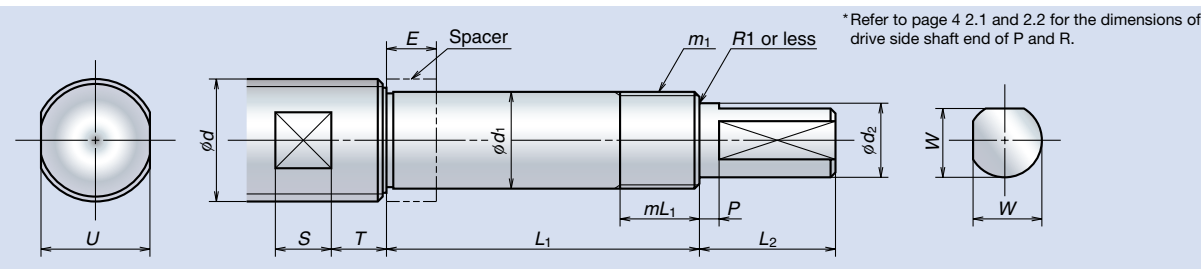

Unit: mm

Support unit		Spacer	Screw shaft	Bearing journal		Lock nut thread		Drive section		Wrench flats				
Reference number		Reference number	Diameter d	Diameter d_1 g6	Length L_1	Nominal m_1	Length mL_1	Diameter d_2 h7	Length L_2	Position P	Depth W	Width across the flats U Tolerance	Position T	Length S
WBK08-01A	WBK08-11	WBK08K	12	8	32	M8×1	9	6	10	2	5.5	$10_{-0.2}^{+0.2}$	4	5.5
WBK12-01A	WBK12-11	WBK12K	15	12	35	M12×1	10	10	15	3	9	$12_{-0.25}^{+0.25}$	6	6.5
WBK15-01A	WBK15-11	WBK15K	20	15	50	M15×1	15	12	20	3	11	$17_{-0.25}^{+0.25}$	6	8.5
WBK20-01	WBK20-11	WBK20K	25	20	64	M20×1	16	15	27	4	14	$22_{-0.3}^{+0.3}$	10	11
WBK25-01	WBK25-11	WBK25K	32	25	76	M25×1.5	20	20	33	4	19	$32_{-0.3}^{+0.3}$	10	15
WBK30DF-31		-	40	30	89	M30×1.5	26	25	61	5	24	$36_{-0.3}^{+0.3}$	16	16
WBK35DF-31		-	50	35	92	M35×1.5	30	30	63	5	29	$41_{-0.3}^{+0.3}$	16	18

2.9 Drive side shaft end: A4

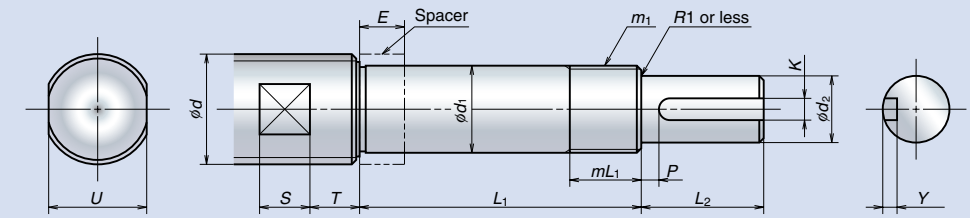

Unit: mm

Support unit		Spacer	Screw shaft	Bearing journal		Lock nut thread		Drive section		Key seat			Wrench flats		
Reference number		Reference number	Diameter d	Diameter d_1 g6	Length L_1	Nominal m_1	Length mL_1	Diameter d_2 h7	Length L_2	Width K N9	Position P	Depth $Y_{-0.1}^{+0.1}$	Width across the flats U Tolerance	Position T	Length S
WBK08-01A	WBK08-11	WBK08K	12	8	32	M8×1	9	6	10	-	-	-	$10_{-0.2}^{+0.2}$	4	5.5
WBK12-01A	WBK12-11	WBK12K	15	12	35	M12×1	10	10	15	2	3	1.2	$12_{-0.25}^{+0.25}$	6	6.5
WBK15-01A	WBK15-11	WBK15K	20	15	50	M15×1	15	12	20	4	3	2.5	$17_{-0.25}^{+0.25}$	6	8.5
WBK20-01	WBK20-11	WBK20K	25	20	64	M20×1	16	15	27	5	4	3	$22_{-0.3}^{+0.3}$	10	11
WBK25-01	WBK25-11	WBK25K	32	25	76	M25×1.5	20	20	33	6	4	3.5	$32_{-0.3}^{+0.3}$	10	15
WBK30DF-31		-	40	30	89	M30×1.5	26	25	61	8	5	4	$36_{-0.3}^{+0.3}$	16	16
WBK35DF-31		-	50	35	92	M35×1.5	30	30	63	8	5	4	$41_{-0.3}^{+0.3}$	16	18

2.10 Drive side shaft end: A5

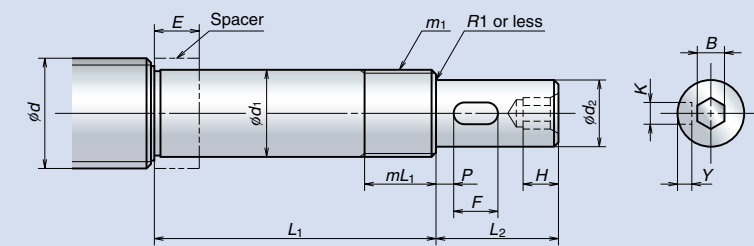

Unit: mm

Support unit		Spacer	Screw shaft	Bearing journal		Lock nut thread		Drive section		Key seat			Wrench flats		
Reference number		Reference number	Diameter d	Diameter d_1 g6	Length L_1	Nominal m_1	Length mL_1	Diameter d_2 h7	Length L_2	Width K N9	Position P	Depth $Y_{-0.1}^{+0.1}$	Length F	Width across the flats $B_{-0.2}^{+0.2}$	Depth H
WBK08-01A	WBK08-11	WBK08K	12	8	32	M8×1	9	6	10	-	-	-	-	-	-
WBK12-01A	WBK12-11	WBK12K	15	12	35	M12×1	10	10	15	-	-	-	-	4	6
WBK15-01A	WBK15-11	WBK15K	20	15	50	M15×1	15	12	20	4	3	2.5	7	5	7
WBK20-01	WBK20-11	WBK20K	25	20	64	M20×1	16	15	27	5	4	3	10	6	8
WBK25-01	WBK25-11	WBK25K	32	25	76	M25×1.5	20	20	33	6	4	3.5	15	8	10
WBK30DF-31		-	40	30	89	M30×1.5	26	25	61	8	5	4	40	10	12
WBK35DF-31		-	50	35	92	M35×1.5	30	30	63	8	5	4	40	12	14

2.11 Spacer

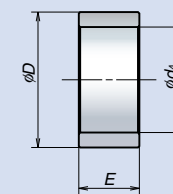

Unit: mm

Reference number	Bearing journal		Spacer dimensions	
	Diameter d	Bore d_1	Diameter D	Width E
WBK08K	8	8	11.5	5.5
WBK12K	12	12	14.5	5.5
WBK15K	15	15	19.5	10
WBK20K	20	20	25.5	11
WBK25K	25	25	32	14